

BIOLOGICALLY ORIENTED PROSTHESES

**BIOPRO**

# First MPJ Hemi Implant

Surgical Technique

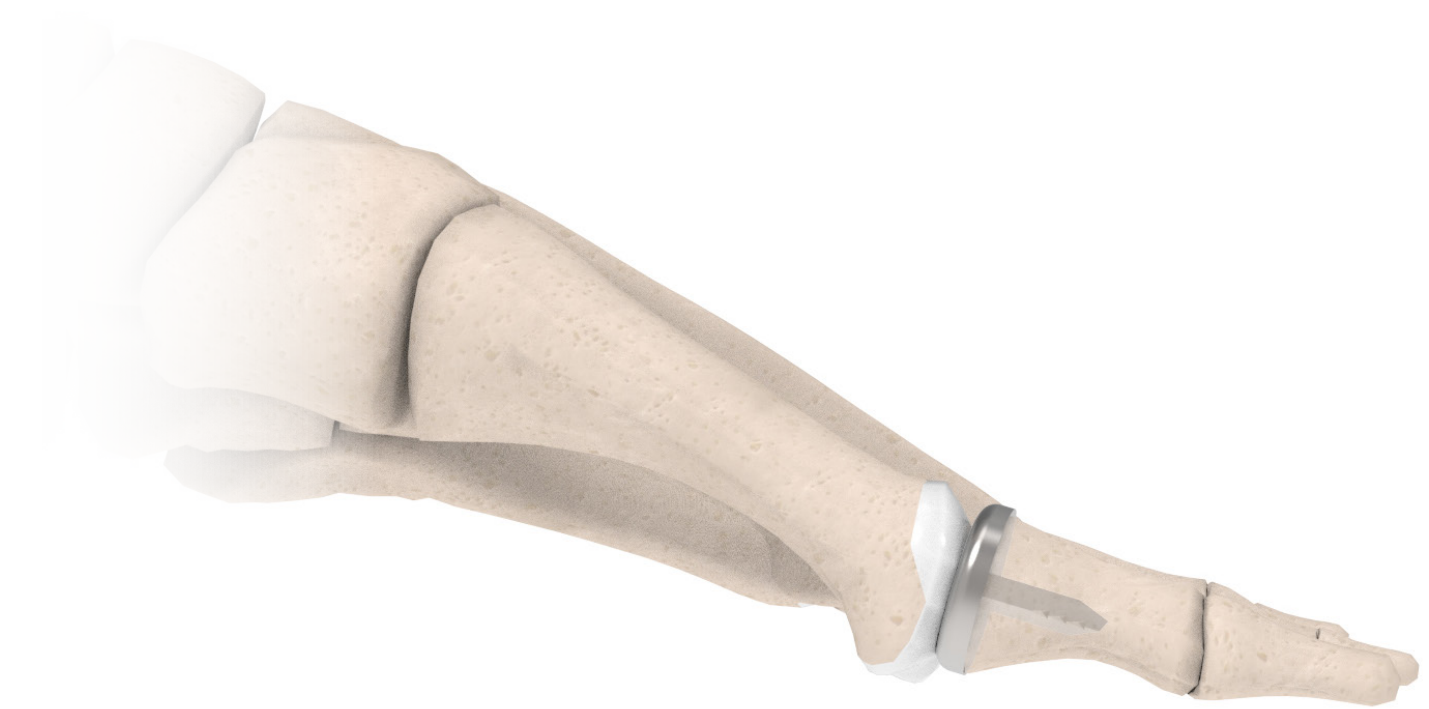

# Contents

## **Table of contents**

---

Indications & Contraindications	1
Implant Specifications	2-3
Instrument Specifications	4-5
Surgical Technique	6-10
Postoperative Images	11
Postoperative Suggestions	12
Implant Ordering	13
Instrument Overview	14

# Indications & Contraindications

## Indications for use:

1. Arthritic degradation of the metatarsophalangeal joint that has resulted in disabling pain, limited motion, and loss of the normal ambulatory function of the forefoot.
2. Degenerative arthritis
3. Rheumatoid arthritis
4. Bunion deformity associated with arthritis of the metatarsophalangeal joint.
5. The titanium version is available for use only in patients susceptible to nickel chromium allergies

## Contra-indications:

1. A general health problem that might pose a significant threat to the life of the patient if subjected to a major surgical procedure.
2. An active infection or a previous infection of the lower extremity that has not been quiescent for at least six months.
3. A local or systemic infection.
4. Significant deficiency in the vascular supply to the extremity.
5. Severe structural deficiency of the sub-chondral bone that may result in insufficient support for the prosthesis.
6. A condition of the toe which may lend itself to a more conservative procedure.
7. Severe compromise of the supporting muscles or ligaments about the toe.
8. Foreign body sensitivity to metals including cobalt chrome or titanium. Where material sensitivity is suspected, appropriate tests should be made prior to implantation.

## Precautions and Handling

- Inspect the sterile blisters used for the implants prior to use. Sterilization cannot be assured, and implants should not be used if blister or seal is damaged.
- Implants are single use devices.
- Do not autoclave implants.
- Exercise caution while threading the impactor tip into the handle to avoid cross-threading, as this can result in damage or the failure of the impactor tip.

## Potential Complications and Adverse Effects

- Allergic reactions to metal
- Delayed healing
- Loosening or migration of the implant
- Subluxation or dislocation of implant resulting in reduced range of motion
- Bone fracture by trauma or improper surgical technique
- Pain due to bone remodeling or reaction to implant components

Contact surgeon if a change in performance or pain level is noticed.

## MR Safety Information

Cobalt Chrome devices have been evaluated for safety and compatibility in the MR environment and are MR conditional. Contact BioPro for MR parameters. Warning: Titanium devices have not been evaluated for safety and compatibility in the MR environment and have not been tested for heating or migration in the MR environment. The safety of titanium devices in the MR environment is unknown. Scanning patients who have these devices may result in patient injury.

## Stages of Hallux Rigidus/Limitus

**Stage I:** Joint inflammation and jamming of dorsiflexion motion in propulsion are the hallmarks of Stage I. These patients will have a normal, non-weight bearing range of motion and you will not note any X-ray changes.

**Stage II:** In this stage, patients begin to show objective clinical signs in addition to the inflammation of Stage I. You will note a dorsal proliferative response that is palpable and evident on X-ray as well. The patient will have a limited range of motion in sagittal formation and one may see some narrowing of the joint space on X-ray.

**Stage III:** This is an advanced Stage II with significant objective findings. One will see changes in the contour of the joint that are secondary to compressive forces in propulsion. There will be a flattening of the metatarsal head in the sagittal and transverse plane that you can see clinically and radiographically as a widened joint dorsally and laterally. These patients will often have proliferative disease with a "Valente" spur. X-rays will also show narrowing of the joint space secondary to thinning of articular cartilage.

**Stage IV:** In Stage IV hallux limitus/rigidus, there is severely advanced degenerative joint disease with complete loss of articular cartilage on both sides of the joint as well as a loss of joint space. The joint is flattened and wide in all planes with severe limitation of motion in all planes and directions.

The BioPro First MPJ Hemi Implant is recommended for stages II, III.

# Implant Specifications

## Description

The BioPro® First MPJ Hemi Implant is a simple, low-profile, press-fit implant designed to replace the articular surface of the proximal phalanx in a painful, arthritic metatarsophalangeal (MTP) joint. Backed by 70+ years of clinical data, the First MPJ Hemi Implant is proven to offer restoration of motion and pain relief, with a minimal bone resection technique.

## Material

Manufactured from Cobalt Chrome, a highly biocompatible and durable material. A titanium version is available for use in patients susceptible to nickel chromium allergies. The MELISA blood test may be performed to confirm a patient's potential metal sensitivities.

## Implant Variations

Available in non-porous coated (NPC) with a porous coated (PC) option for improved biological fixation.

## Sizing

Available in five standard sizes, the profile thickness remains the same across all sizes.

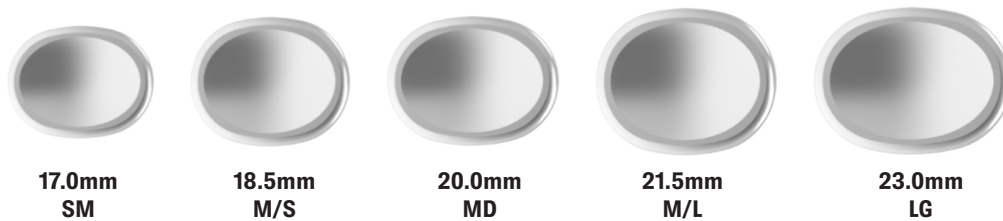

## Features

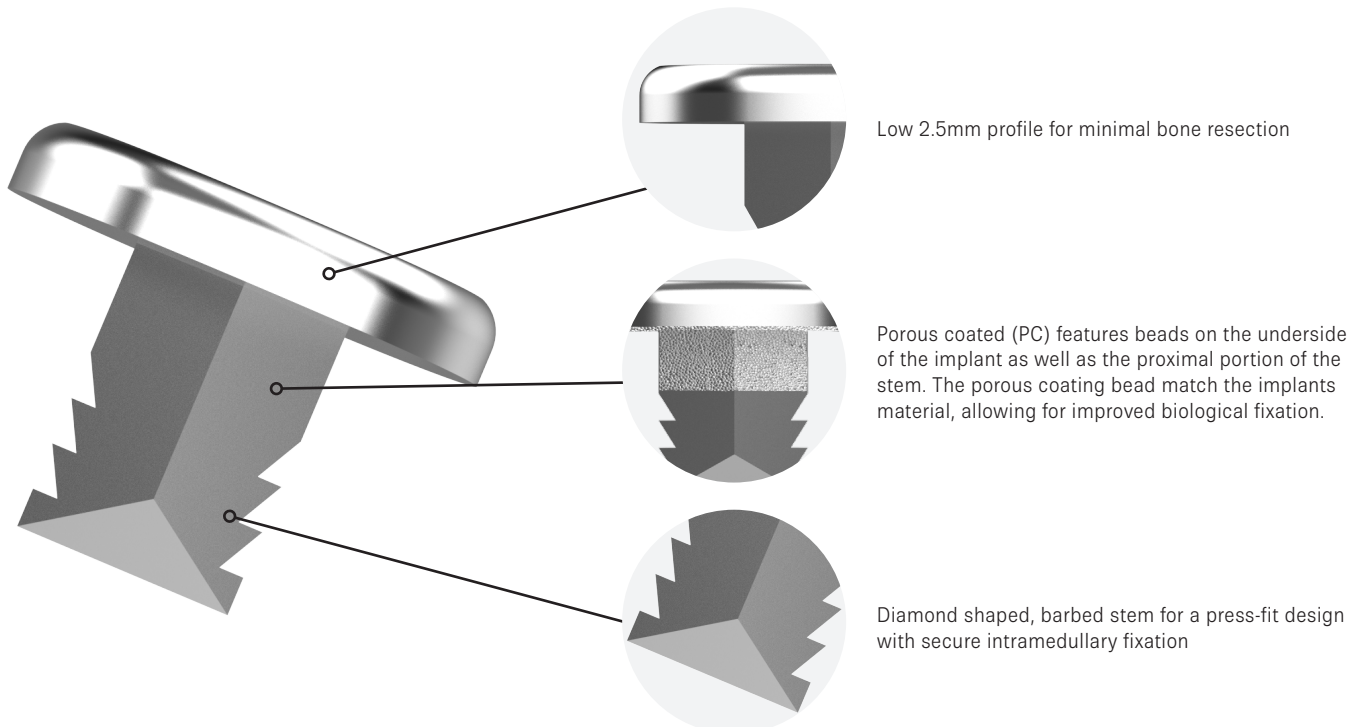

# Implant Specifications

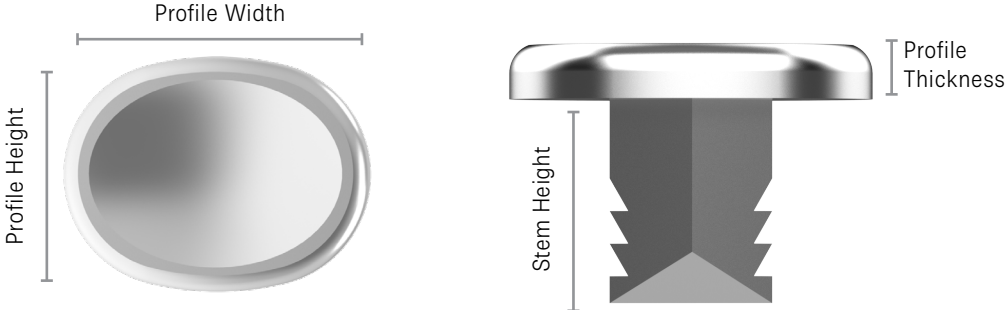

Description	Profile Width	Profile Height	Stem Height*	Profile Thickness*
<b>SM 17.0mm</b>	17.0mm	13.0mm	9.5mm	2.5mm
<b>M/S 18.5mm</b>	18.5mm	15.0mm	10.5mm	2.5mm
<b>MD 20.0mm</b>	20.0mm	15.0mm	11.0mm	2.5mm
<b>M/L 21.5mm</b>	21.5mm	17.5mm	12.0mm	2.5mm
<b>LG 23.0mm</b>	23.0mm	17.5mm	12.5mm	2.5mm

\*Beads on Porous Coated (PC) Implants add an additional 1mm. Rounded to the nearest .5mm

# Instrument Specifications

## Color Coding

The five star template, trial implants and packaging all feature a color coding system to coordinate implant size. After determining the appropriate implant size, always ensure you are using the same color code throughout the procedure.

Size	Color
SM - 17mm	Red
M/S - 18.5mm	Blue
MD - 20mm	Green
M/L - 21.5mm	Yellow
LG - 23mm	Black

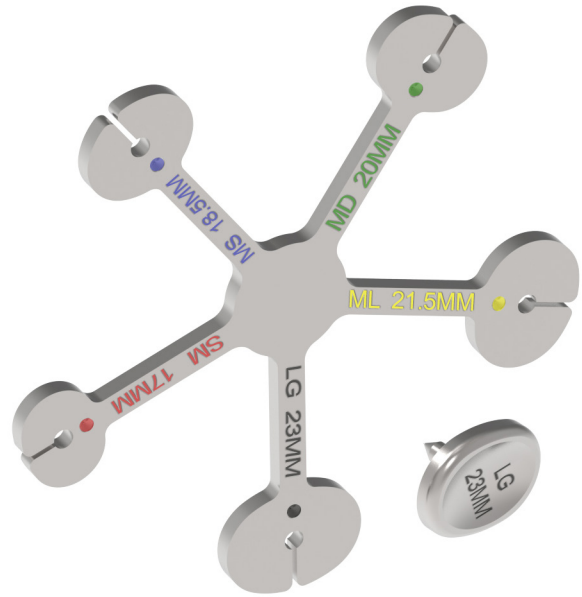

# Instrument Specifications



## **Broaching**

The instrument kit includes both a trial punch and toe punch for compression broaching. It is imperative to the success of the implant that these are inserted parallel to the long axis of the proximal phalanx.



Fluoroscopy may be used to ensure proper insertion angle prior to final placement.

# Surgical Technique



## **Step One:**

Begin by exposing the first metatarsophalangeal joint by either a dorsal medial or medial incision. In the majority of cases, the pathology presents itself as a rectus joint and therefore requires minimal medial/lateral subcutaneous dissection.

Continue with a capsular incision which extends the full length of the skin incision with placement at least one centimeter medial to the long extensor tendon. This will prevent capsular under roll and provide easier closure at the end of the procedure. Perform precise capsular dissection about the head of the first metatarsal and approximately 1/2 of the proximal phalanx. Follow proximal phalanx dissection along the entire medial and lateral segments. This will help facilitate easy removal of the osteotomized base.

## **Step Two (Optional):**

Remove a small segment of dorsal bone overgrowth or cupping on the base of the proximal phalanx with a rongeur to identify the "zone of articular cartilage".



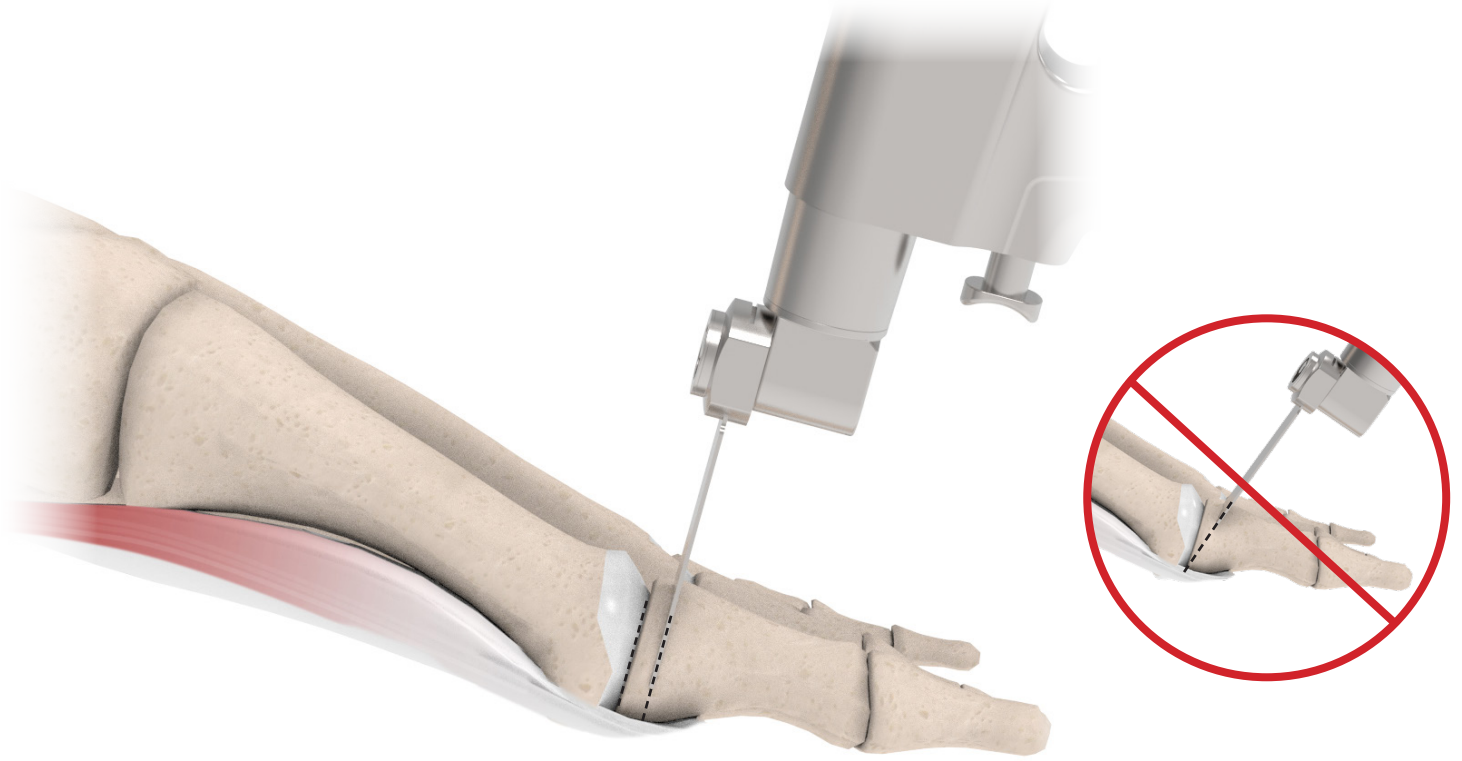

**Step Three:**

Resect approximately 4 to 6mm off the base of the proximal phalanx. The saw blade is placed parallel to the articular surface and perpendicular to the long axis of the proximal phalanx.

**Caution**

Care is taken not to cut the flexor hallucis brevis on the plantar surface. Anything greater than 6mm may detach the insertion of the flexor hallucis brevis.

**Caution**

Failure to cut at 90° can result in the implant stem impacting or breaking through the plantar cortex.

*Surgical Pearl (Optional)*

When performing the osteotomy, progress from dorsal to plantar approximately 3/4 through the bone. Remove the saw and insert a small chisel. Bend slightly to create a greenstick fracture. Remove this dorsal bone component leaving the plantar edge intact. Grasp the center of the proximal phalanx with the enclosed bone clamp to easily distract the joint. Carefully dissect free the tendon fibers of the short flexor tendon attached to the bone shelf. Once freed completely, remove the shelf with a power saw. This will ensure the insertion of the short flexor tendon is maintained.

*Surgical Pearl*

In the event the flexor hallucis brevis is inadvertently cut, drill a small hole on an angle from approximately 3-4mm above the plantar surface on the base of the proximal phalanx and out the plantar surface of the phalanx. Pass a small suture through this hole and secure it to the flexor hallucis longus.

**Step Four:**

Remodel the metatarsal head and remove all abnormal or irregular bone with a power saw, burr or rasp, taking care to maintain as much dorsal cartilage as possible.

*Surgical Pearl*

It is advisable to frequently irrigate the surgical site. It is at this point of the surgical procedure that metatarsal head osteotomies may be performed, if warranted.

*Surgical Pearl*

Release the sesamoid complex with an elevator instrument. Failure to release the sesamoids can result in limited postoperative range of motion.

**Step Five:**

Implant selection is made using the 5-star template. Plantarflex the proximal phalanx and abut the template to the phalanx. Select the appropriate size (17MM, 18.5MM, 20MM, 21.5MM, 23MM) so the implant is slightly larger than the circumference of the base.

This allows the cortex to maintain stability of the implant and prevents the possibility of implant telescoping or bone overgrowth.

**Step Six:**

Using the 5-star template center hole, insert the trial punch and tap to stop point. Ensure the trial punch is inserted parallel to the long axis of the phalanx and is positioned perpendicular to the implant template. Remove the punch and template.

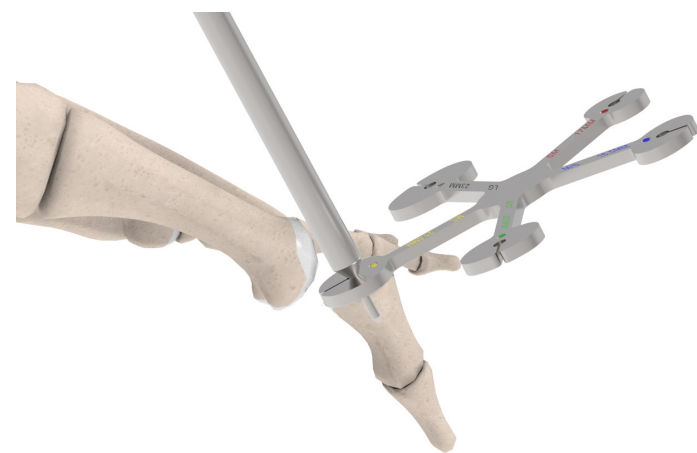
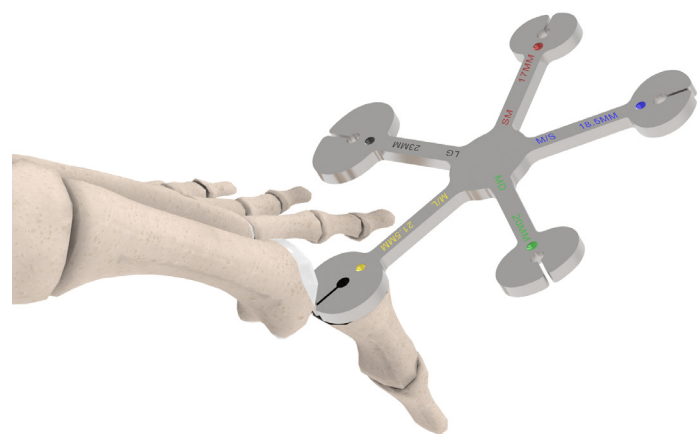

**Step Seven:**

The appropriately sized trial implant is now inserted into the hole created by the trial punch. Verification of the correct size is made and the hallux put through the normal range of motion. It is at this time that final remodeling of the metatarsal head is made if required. The Trial Implant should move freely about the metatarsal head with no evidence of medial or lateral deviation along with the absence of clicking. Abnormalities are corrected by fine burring technique.

**Important Note**

Evaluate joint tension while the Trial Implant is in place to ensure appropriate resection has been made. When fully distracting the proximal phalanx from the metatarsal head, approximately 5mm of joint space should be observed. If less than 5mm is possible, there is insufficient resection and the final joint may be tight and lack motion. Additional resection of the phalanx may be necessary.

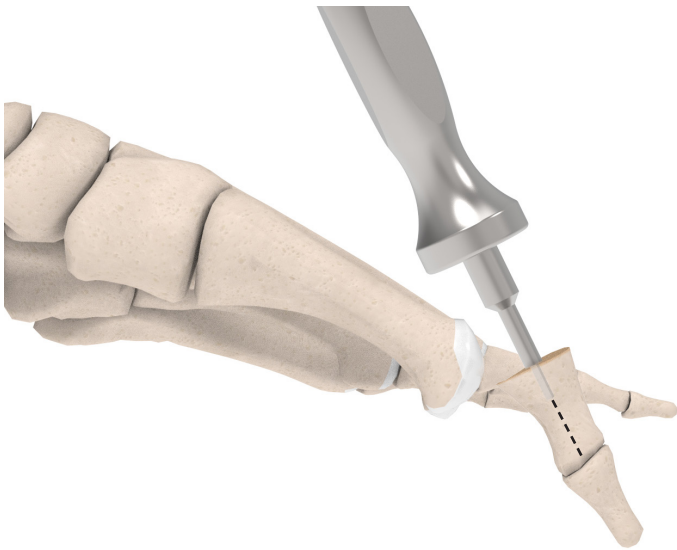
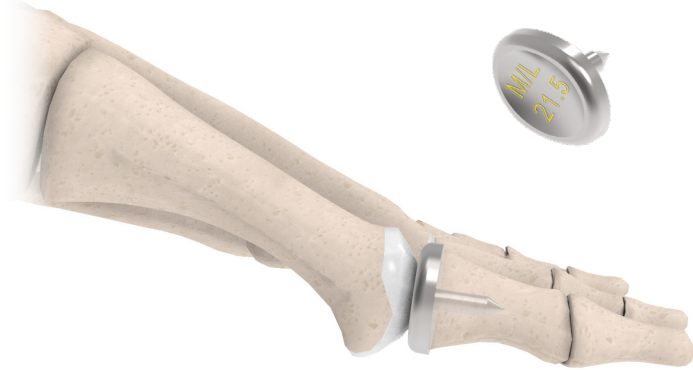
**Step Eight:**

The final impression is created with the toe punch. The toe punch is centered at the trial punch hole and forward hand pressure is applied with slight medial lateral movement using the corners of the reamer to assist in bone penetration. Continue penetration of the toe punch to the stop mechanism. A mallet may be used if hard bone prevents insertion of the toe punch with hand pressure only.

**Important Note**

It is imperative that the toe punch be perfectly parallel with the long axis of the proximal phalanx. Fluoroscopy may be used to ensure proper insertion angle prior to final placement.

**Important Note**

The toe punch is slightly undersized to a non-coated implant stem. When using the porous coated implant in combination with hard bone stock, the porous beads on the stem may make fully seating the implant difficult. In these instances, a small pencil burr (approximately 2.5mm) may be used to slightly open the concavity created with the toe punch, no more than 0.5mm on each side and 4-5mm deep.

**Step Nine:**

Insert the appropriate size implant into the canal. Final seating is performed using the impactor fitted with the appropriately sized impactor tip until the implant is flush with the bone.

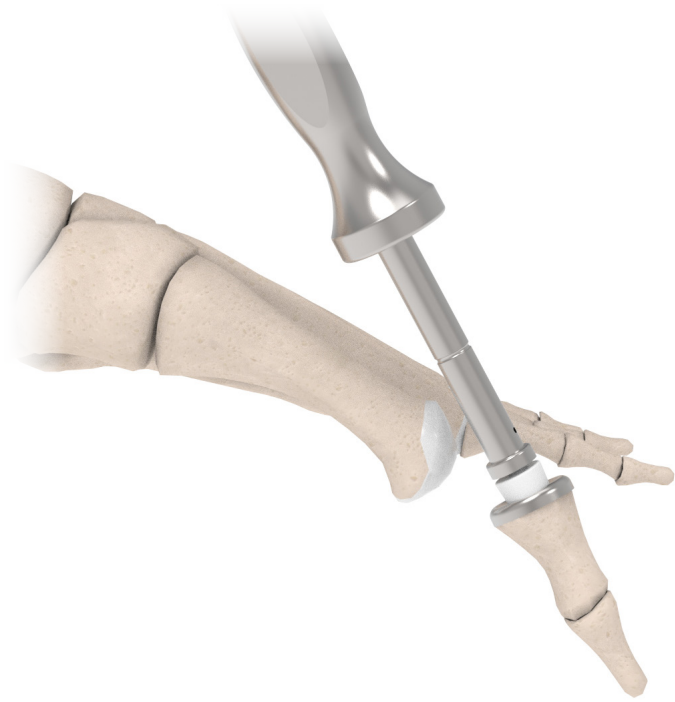

**Step 10**

Once again, perform joint range of motion followed by closure of all layers with sutures of choice.

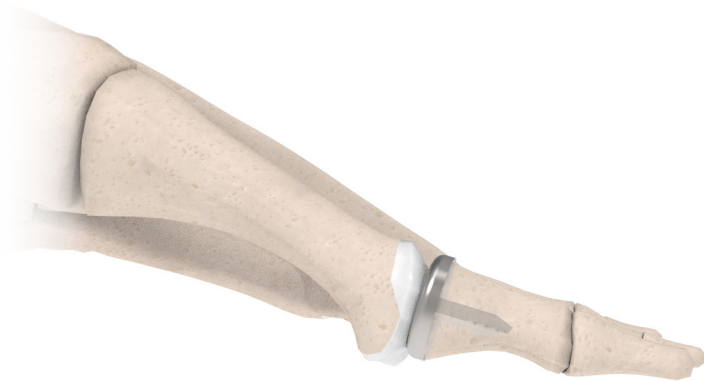

# Postoperative Images

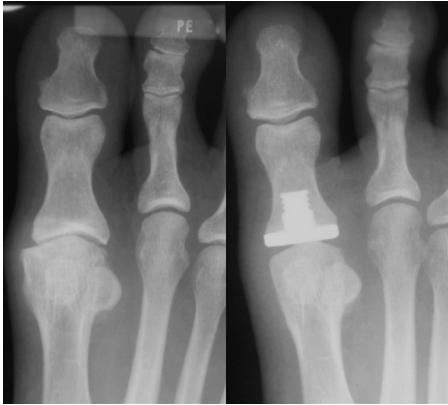

Pre-op

Post-OP



Pre-op

Post-OP



Pre-op

Post-OP



Pre-op

Post-OP



with hallux valgus correction



38 year post-op

# Postoperative Suggestions

- Partial to full weight-bearing is permitted at the discretion of the surgeon. A standard post-operative shoe or wedge shoe is used for the first 3 weeks.
- Dressings are changed for 3 weeks, with sutures usually removed at the 2 week period.
- Passive range of motion (dorsiflexion and plantarflexion) is permitted by the 2nd or 3rd post-operative week.
- Physical therapy and return to soft shoes is usually permitted by the 3rd to 4th post-operative week.

# Implant Ordering

<b>Item #</b>	<b>Description</b>	<b>Size</b>	<b>Color Code</b>
10412	Cobalt Chrome Porous Coated SM	17mm	Red
17034	Cobalt Chrome Porous Coated M/S	18.5mm	Blue
10413	Cobalt Chrome Porous Coated MD	20mm	Green
14960	Cobalt Chrome Porous Coated M/L	21.5mm	Yellow
10414	Cobalt Chrome Porous Coated LG	23mm	Black
10060	Cobalt Chrome Non-Porous Coated SM	17mm	Red
17033	Cobalt Chrome Non-Porous Coated M/S	18.5mm	Blue
10061	Cobalt Chrome Non-Porous Coated MD	20mm	Green
14958	Cobalt Chrome Non-Porous Coated M/L	21.5mm	Yellow
10062	Cobalt Chrome Non-Porous Coated LG	23mm	Black
17035	Titanium Porous Coated SM	17mm	Red
17197	Titanium Porous Coated M/S	18.5mm	Blue
17036	Titanium Porous Coated MD	20mm	Green
17037	Titanium Porous Coated M/L	21.5mm	Yellow
17038	Titanium Porous Coated LG	23mm	Black
16813	Titanium Non-Porous Coated SM	17mm	Red
17198	Titanium Non-Porous Coated M/S	18.5mm	Blue
16814	Titanium Non-Porous Coated MD	20mm	Green
16815	Titanium Non-Porous Coated M/L	21.5mm	Yellow
16816	Titanium Non-Porous Coated LG	23mm	Black

# Instrument Overview

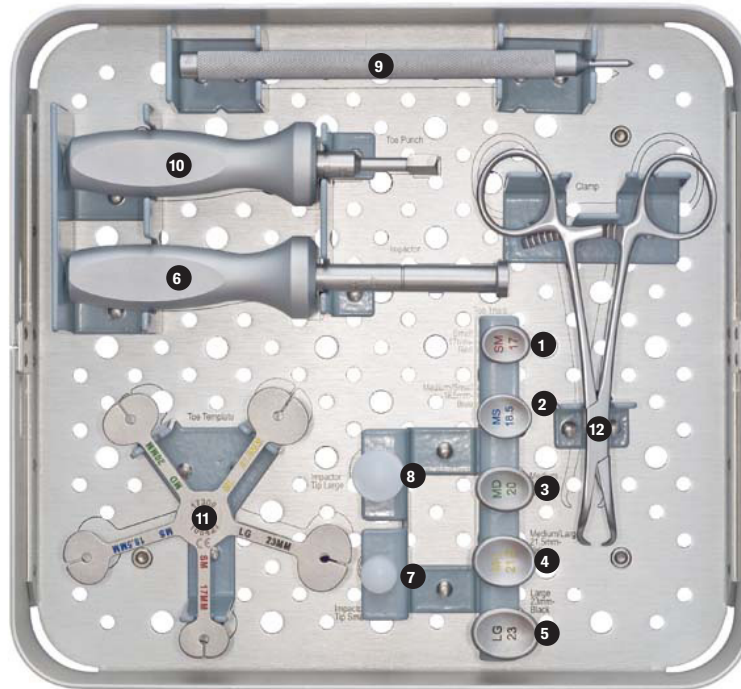

**First MPJ Hemi Instrument Kit -17368**

Location	Item #	Description
1	12235	MPJ Trial 17mm (SM)
2	17180	MPJ Trial 18.5mm (MS)
3	12236	MPJ Trial 20mm (MD)
4	14959	MPJ Trial 21.5mm (M/L)
5	12237	MPJ Trial 23mm (LG)
6	15259	Impactor Handle
7	15256	Impactor Tip Sm
8	15257	Impactor Tip Lg
9	17786	Trial Punch
10	15112	Toe Punch
11	17309	5-Star Template
12	18100	Towel Clamp
	18060	First Mpj Instrument Tray



This page intentionally left blank.

This page intentionally left blank.

This page intentionally left blank.

BIOLOGICALLY ORIENTED PROSTHESES  
**BIOPRO**

Call us at 1-810-982-7777 to schedule a case today.

This content is provided as an educational tool only and is not meant as medical advice in the usage of specific BioPro products. A healthcare professional must use their professional judgment in making any final determinations in product usage and technique. The product's Instructions for Use, should always be reviewed prior to surgery. Postoperative management is patient-specific and dependent on the treating professional's assessment. Individual results will vary and not all patients will experience the same postoperative activity level or outcomes. This information does not constitute medical, legal, or any other type of professional advice and should not be relied upon as such. It is not to be redistributed, duplicated, or disclosed without the express written consent of BioPro, Inc.



BioPro, Inc.  
2929 Lapeer Road, Port Huron, MI 48060, USA  
info@bioproimplants.com | 1-810-982-7777  
[www.bioproimplants.com](http://www.bioproimplants.com)

